

4K Ultra HD PTZ Camera

User Manual (V2.0)

Content

I、Precaution	2
II、Product Introduction	3
2.1 Camera Technical Parameters	3
2.2 Product Feature	4
III、Using Instructions	6
3.1 Camera Overview & Interface Distribution.....	6
3.2 RS232 Interface Specification.....	10
3.3 RS422 Interface Specification.....	10
3.4 Camera Dimension.....	11
3.5 Remote control button function description.....	12
3.6 Menu Setting	13
IV、Network Connection	17
4.1 Operating Environment.....	17
4.2 Connection Mode	17
4.3 GUI Operation.....	18
V、Installation Instruction	37
5.1 Install the camera on the table	37
5.2 Install the camera on a tripod.....	37
5.3 Install the camera to a high location (ceiling).....	38
VI、Maintenance Service Terms	40
Warranty Card	42

I、Precaution

Electrical Safety

During the installation and use of this product, must be strictly complied with various national and regional electrical safety standards. The Products is no power switch on the body . When the product fails, please Plug out the power supply of the socket immediately or Plug out the connection between the power supply and the socket.

Transport with care

During transportation, storage and installation, it is necessary to prevent damage to the product caused by heavy pressure, severe vibration, soaking etc.

Power Polarity

This product uses a DC 12V power supply, and the polarity of the power plug is shown in the figure below picture.



Be care to installation

- Do not rotate the head of camera in forcefully, otherwise it may cause mechanical failure of the camera.
- This product should be placed on a horizontal and stable table, and should not be installed tiltedly, otherwise it may cause the image output is be skewed.
- This product is part of the shell which was made of plastic organic materials, and it should not be in contact with various corrosive liquids, gases or solid substances, otherwise the shell will be corroded and deformed.make sure that there are no obstacles within the rotation range of the gimbal, when installing.
- Do not power on until all installations are complete.

Prohibited Unauthorized Disassemble

There are no user-serviceable parts in this product, and the damage caused by disassembly by the user is not belong of the warranty ranged

II、Product Description

2.1 Camera Technical Parameters

Model	20X	30X
Specifications		
CMOS Sensor	1/1.8" CMOS	1/1.8" CMOS
Effective Pixels	8.3 Megapixels	
Video Format	2160P60/59.94、2160P50、2160P30/29.97、2160P/25；1080P60/59.94、1080P50、1080P30/29.97、1080P25；1080i60/59.94、1080i50；720P60/59.94、720P50	
Optical Zoom	20x Optical Zoom 12X Digital Zoom	30x Optical Zoom 12X Digital Zoom
Focus Length	f=7.1~141.3mm	f=7.1~211.95mm
HFOV	3.6°(T) ~ 59.2°(W)	2.5°(T) ~ 59.2°(W)
Iris	F1.61 ~ F5.19	F1.61 ~ F5.19
Min Illumination	0.05 lux (F1.61)	
Digital Noise Reduction	2D&3D Noise Reduction	
White Balance	Manual/Auto/Indoor/outdoor/One Push/3000K/4000K/5000K/6500K/ATW	
Focus mode	Manual/Auto/Z- Trigger	
Iris mode	Manual/Auto	
BLC	1-8/Off	
Picture adjustment	Brightness, Hue, Saturation, Contrast, Sharpness	
I/O Parameters		
Video Output Interface	HDMI2.0、12G-SDI*2、RJ45、USB3.0	
Video Compression Format	MJPEG	
Control interface	1X RS232 IN, 1X RS232 Out, 1X RS422 IN, 1X RS422 Out , 1X RJ45	
Control Protocol	VISCA /PELCO-D / PELCO-P、VISCA OVER IP、ONVIF、UVC (ONLY FOR USB INTERFACE)	
Baud Rate	2400/4800/9600/19200/38400bps	
Audio Input	Dual channel 3.5mm line input	
Audio Compression	ACC、G711A、G711U	
Network Interface	1000M Internet Access(10/100BASE-TX)	
Network Protocol	RTSP、RTMP、ONVIF、NDI HX3、SRT、GB28181、VPN	
Power Interface	DC-038 Outlet(DC12V),	
Pan/Tilt Mechanical Parameters		
Pan Rotation Angle	-175°~ +175°	
Tilt Rotation Angle	-30°~ +90°	
Horizontal rotation speed range	0.1~100°/s	
Vertical rotation speed range	0.1~80°/s	
Presets	Max Support 255 Presets	
General Parameters		
Power Adapter	AC100V~AC240V Input, DC12V/2A Output	
Input Voltage	DV12V	
Power Consumption	15W (Max)	
Storage Environment	-10°C ~ +60°C / 20% ~ 95%	
Working Environment	-10°C ~ +50°C / 20% ~ 80%	

2.2 Product Features

2160P Full High-definition

Adopt 8.3 Megapixels high quality CMOS sensor, can reach maximum 3840×2160 resolutions and output frame rate up to 60fps.

Various optical zoom lenses

20X, 30X Various optical zoom lenses for option.

Low Noise

High SNR of CMOS sensor, combined with 2D and 3D noise reduction algorithm, it effectively reduces the noise, even under low illumination conditions, to ensure that the picture can still remain clear picture quality.

Abundant Video Output and Communication Interface

To Support simultaneous in HDMI2.0 4K UHD Video Output, 4K IP Streaming and 4K USB3.0 Uncompressed UVC output,Especially for Dual 12G-SDI Synchronous Output for Live & Recording in Broadcasting Events.

Quiet Pan and Tilt Movement

Using high-precision stepping motor and advance motor driven chip to make sure it rotates smooth & higher accurate and without any Noise under different Pan / Tilt speed.

Remote Control

The camera can be remote controlled using RS232, RS422 or IP network, USB 3.0 and supports VISCA, PELCO-P/D, ONVIF, UDP, UVC protocols.

Presets Freezing

The camera supports the preset freeze function. Users can enable this function and use the preset function to realize free switching of scenes.

Multi-preset

It can Max Support to 255 presets. (Remote control can only set 10 presets.)

Multi-application Scenario

Widely applicable to broadcasting studios, Educational recording, Conference AV, Telemedicine, remote training, Court trial systems, Church , and Event live Streaming.

Multiple Network Protocol

Support ONVIF, RTSP, RTMP, NDI|HX3, SRT protocols, and can be expanded according to user needs.

Support Double Color Tally light

There is a red and green two-color tally light with adjustable brightness in front of and behind the camera lens.

Support 360° all-round infrared receiving range

There are IR Receiver on the front, rear and top of the camera base, and the user can control the camera at any angle throughIR remote control.

III、 Using Instructions

3.1 Camera Interface and Function

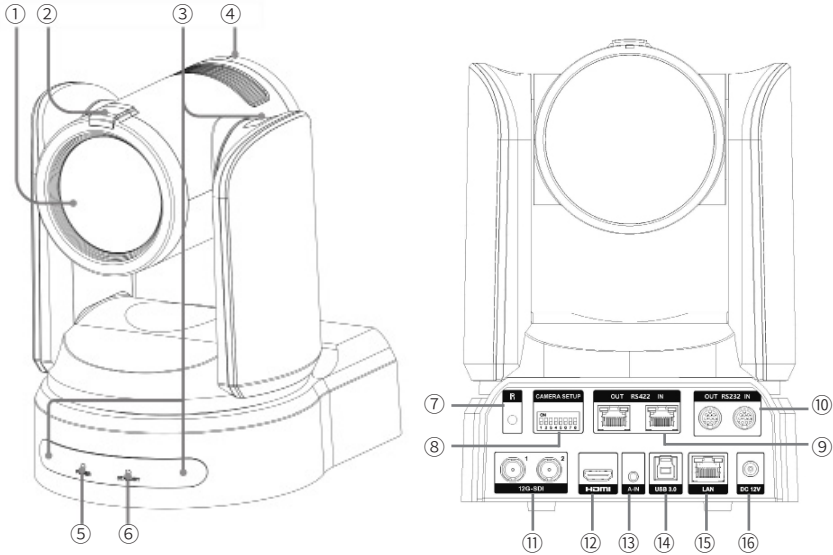

① Lens

② Front-side Tally light

③ IR Receiver

④ Backside Tally Light

⑤ Power Indicator Light

⑥ Standby Indicator Light

⑦ Tail IR Receiver

⑧ DIP Switch

⑨ RS422 Interface

⑩ RS232 Interface

⑪ 12G-SDI Interface

⑫ HDMI2.0 Interface

⑬ 3.5mm Audio Input

⑭ USB3.0 Type-B Interface

⑮ LAN Interface

⑯ DC12V Power Interface

① Lens

This lens is an optical zoom lens, when the DZOOM function is turned on in the menu, the camera can zoom in digital up to 10 times.

② Front-side Tally light

When receiving the VISCA tally command, the camera lights up the red or green tally light (the color depends on the command), and you can choose HIGH, MID, LOW, OFF and other options in the tally mode of the menu to control the brightness of the Tally light or turn off the tally light.

③ IR Receiver

These sensors are used to receive the IR signal from the remote.

④ Backside Tally Light

When VISCA tally command is received, it will be on or off synchronously with the front tally light.

⑤ Power Indicator Light

When the camera is powered on, the green POWER indicator is on, and when the camera self-checking is completed, the green indicator flashes 3 times and then stays on. If the camera receives an operation instruction from the provided infrared remote control, the green indicator light will be flash. When the camera enters standby mode, the green light turns off.

⑥ Standby Indicator Light

When the camera is powered on, the red standby indicator light is on, and when the Camera self-checking is completed, the red indicator light flashes 3 times and then goes out. When the camera enters standby mode, the red indicator light is always on.

⑦ Tail IR Receiver

Used to receive the infrared signal of the remote control.

⑧ DIP switch

Used to set the address ID, baud rate and protocol of the camera.

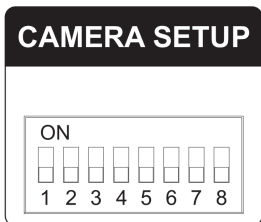

Switch number		Setting Item	
1	2	3	Camera ID
OFF	OFF	OFF	Setting By Menu
ON	OFF	OFF	1
OFF	ON	OFF	2
ON	ON	OFF	3
OFF	OFF	ON	4
ON	OFF	ON	5
OFF	ON	ON	6
ON	ON	ON	7

①②③ used to set the camera ID. It will be valid after reboot camera.

Switch number		Setting Item	
4	5	Baud Rate	
OFF	OFF	Setting By Menu	
ON	OFF	4800bps	
OFF	ON	9600bps	
ON	ON	19200bps	

④⑤ used to set the camera baud Rate. It will be valid after reboot camera.

Switch number		Setting Item	
6	7	Agreement	
OFF	OFF	Setting By Menu	
ON	OFF	VISCA	
OFF	ON	PELCO-D	
ON	ON	PELCO-P	

⑥⑦ used to set the camera Communication Protocol. It will be valid after reboot camera.

⑨ RS422 Interface

When using RS422 to connect multiple cameras, connect the RS422 IN to the RS422 OUT interface of the previous camera, and connect the RS422 OUT to the RS422 IN interface of the next camera. For specific pin definitions, see "3.3 S422 Interface Description"

⑩ RS232 Interface

When using RS232 to connect multiple cameras, connect the RS232 IN to the RS232 OUT interface of the previous camera, and connect the RS232 OUT to the RS232 IN interface of the next camera. For specific pin definitions, see "3.2 RS232 Interface Description".

⑪ 12G-SDI Interface

The image signal is output in the SDI video signal format, and the dual- SDI interfaces are output simultaneously.

This interface can support with a maximum resolution of 3840*2160@60fps.

⑫ HDMI2.0 Interface

Using the HDMI video signal format to output the image signal.

⑬ 3.5mm Audio Input

3.5mm dual-channel universal audio input interface, which can be connected to the audio output interface of a microphone or other audio players. The input audio signal can be output simultaneously through network stream, UAC, HDMI, SDI etc.

⑭ USB3.0 Type-B Interface

Using UVC or UVC+UAC to output the video and audio signal.

⑮ LAN Interface

The maximum bandwidth is 1000M, which is used for network communication and Stream or POE+ power.

⑯ DC12V Power Interface

DC12V Input, connect to external power adapter(provide)

3.2 RS232 Interface Definition

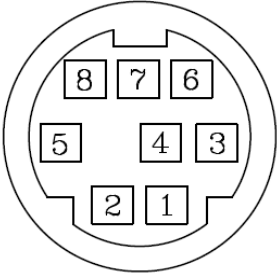

How to connect the computer or control keyboard to the camera

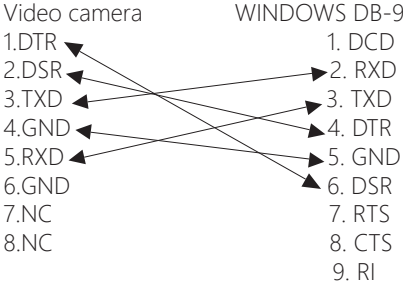

NO.	Function	Definition
1	DTR	Data Terminal Ready
2	DSR	Data Set Ready
3	TXD	Transmit Data
4	GND	Ground
5	RXD	Receive Data
6	GND	Ground
7	NC	No Connect
8	NC	No Connect

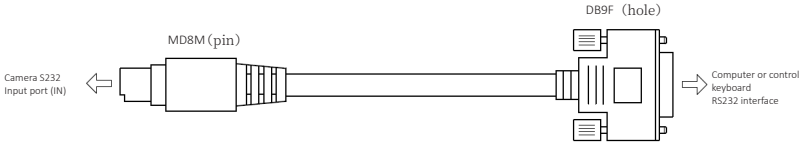
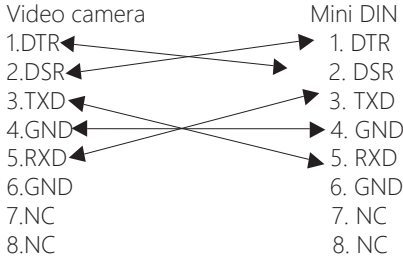

3.3 RS232 Interface Specification

VISCA RS-422 pin array

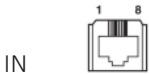

Pin number	Function
1	TX-
2	TX+
3	RX-
4	GND
5	GND
6	RX+
7	N.C
8	N.C



Pin number	Function
1	RX-
2	RX+
3	TX-
4	GND
5	GND
6	TX+
7	N.C
8	N.C

3.4 Camera Dimensions

The Size for 4K Ultra HD PTZ camera is as below:(mm)

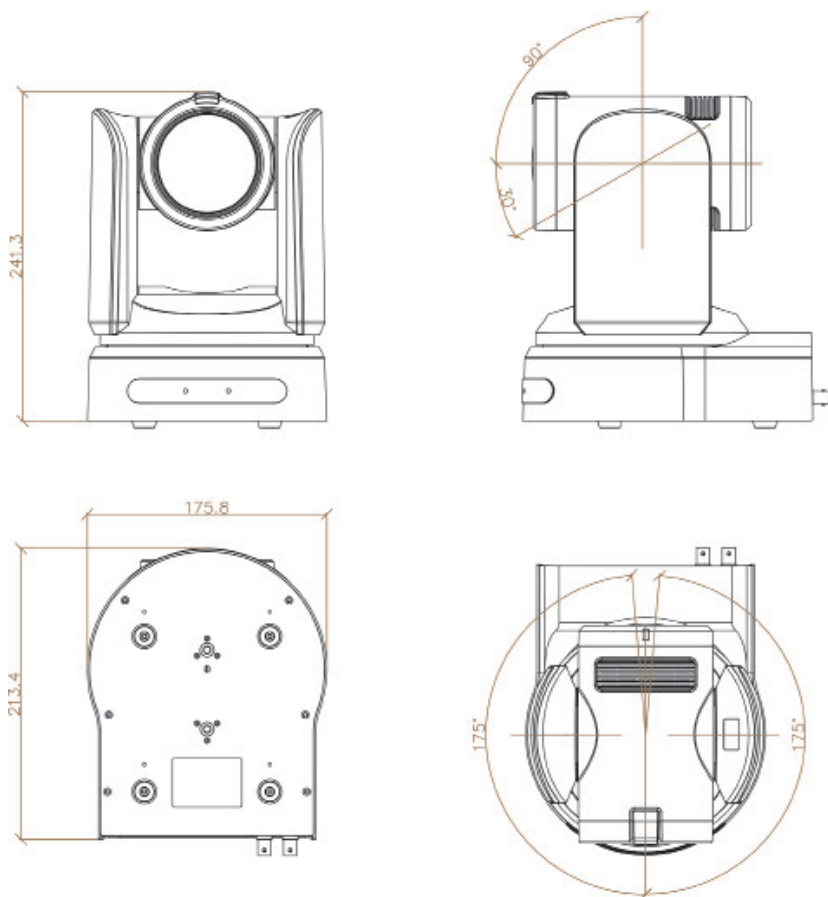

3.5 Remote control button function description

Item#	Button & Key Named	Function Description
1	Power Key	press the key to power on the camera, or the camera enters standby mode
2	P/T RST Key	Press this button to allow the camera's horizontal motor and vertical motor to perform a self-checking again. After the self-checking is completed, the camera will stop at the HOME position. If the user has set the No. 1 preset position, then the camera will stop at Presets 1 Position after the self-checking is completed
3	FLIP Key	Press this button to make the camera enter flip mode, at this time the camera screen will automatically flip 180°, and the rotation direction of the camera will also change, press this button again to exit flip mode.
4	Camera ID Select Key	Select the button corresponding to the address of the camera you want to operate with the infrared remote control. When the address of the camera is greater than 4, select channel 1. If two or more cameras are adjacent and have the same camera address, you can use the infrared remote control to control them at the same time. If you need to control one of the cameras separately, please modify the address of each camera to a different
5	BLC Key	Turn on/off Backlight Compensation
6	Menu Key	Enter/Exit OSD Menu
7	HOME	Press HOME key, The camera will return to the exact center position
8	Direction key	Press the button to make the camera rotate the pan/tilt according to the direction of the arrow. When the menu is opened, use the up and down arrow keys to select menu items, and the left and right arrow keys to modify the parameter value
9	Preset Key	[Preset] + [Number Key] within 3 Seconds to Setting Presets. The camera will save the current position, lens multiplier, focus position and other parameters in the preset location in corresponding to the number key pressed.
10	Reset Key	[Preset] + [Number Key] within 3 Seconds to Clear Presets.
11	Focus Key	[AUTO] Automatic focus [MANUAL] Manual focus [FAR] Manual focus, make the far object clearer [NEAR] Manual focus, make the near object clearer
12	Zoom Key	[+] The button allows the camera to Zoom In, the shooting angle of the lens gradually decreases, and the distant scenery is enlarged [-] Press the button to make the camera WIDE zoom, the shooting angle of the lens will gradually increase, and the distant scenery will be zoomed out and smaller.
13	Number Key	Press any number key, the camera can call the presets corresponding to the number. Number Key + [Preset] or [reset] buttons, it can be used to save or clear presets

Note:

1. Press the Button in manual is refers to the two actions of pressing and releasing the button. If you need to operate a combination of keys, such as Clear Presets [Reset] + [Number Key], it means to press the [RESET] key first, and Released it then press the [Number Key].

2. When the camera receive the command from IR Remote Control, the light flashes, release the IR Remote Control key, the light will be stop to flash.

3.6 MENU SET

1、Operate remote control, press the **【MENU】** button to display the OSD menu.

2、Press the Up and Down direction key to choose the menu, press Left and Right direction Key to set the function of the menu.

◆ EXPOSURE

Press the **【MENU】** button to display the OSD menu, Press Up/Down key to **【EXPOSURE】** ,Press Right button to enter Sub-menu, as like Picture.

【AE MODE】

Optional Mode: Auto /Shutter Priority /Iris Priority / Bright Priority /Manual.

AUTO Mode: The camera automatically adjusts various exposure parameters valued.

Shutter priority mode: electronic shutter speed can be adjusted in manually, Gain and Iris will adjusted in automatically.

Iris priority mode: Iris parameters can be adjusted manually, gain and electronic shutter speed will adjusted in automatically.

Brightness Priority Mode: Gain can be adjusted manually, Iris and electronic shutter speed will adjusted in automatically.

Manual mode: can manually adjust the electronic shutter speed, Iris and Gain in separately.

【AE LEVEL】

To modify different Exposure parameter with different Mode. It can setting range as follows.

AUTO: N/A

Shutter Priority Mode: 1/25- 1/10000

Iris Priority Mode: F1.6-Close

Bright Priority Mode: Close- F1.6/28DB

MAIN MENU

EXPOSURE

COLOR

PICTURE

P/T/Z

NOISE REDUCE

VIDEO OUT

SYSTEM SETUP

DEFAULT SETUP

EXIT

EXPOSURE

AE MODE: AUTO

AE LEVEL: NA

EXCOMP: ODB

BACKLIGHT: OFF

HLC: 7

FLICKER: 50HZ

BACK

EXIT

【Gain compensation】 : Can be setting in ranged of -10.5DB~10.5DB, off

【EXCOMP】 : To Setting : 1-7/OFF

【HLC】 : To Setting: 0-15

【FLICKER】 : To setting in 50HZ, 60HZ, OFF

◆ COLOR

Press the **【MENU】** button to display the OSD menu, Press Up/Down to **【COLOR】** , Press Right Button to enter Sub-menu,as the right picture.

【WB MODE】

Optional: AUTO/INDOOR/OUTDOOR/ONE-SHOT/ATW/MUNUAL/3000K/4000K/5000K/6500K, default setting Auto .

RED GAIN: When the WB MODE is Manual Status, it can adjust R Gain Valued ranged of 0~255, default setting 18.

BLUE GAIN: When the WB MODE is Manual Status, it can adjust B Gain Valued ranged of 0~255, default setting 16.

【SATURATION】 : To Setting Valued ranged : 60%-200%, default setting 100%.

【COLOR HUE】 : To Setting Valued ranged: 0-14, default setting valued 7.

COLOR	
WB MODE:	AUTO
R GAIN:	18
B GAIN:	16
SATURATION:	100%
COLOR HUE:	7
BACK	
EXIT	

◆ PICTURE

Press the [MENU] button to display the OSD menu, Press Up/Down to **【PICTURE】** , Press Right Button to enter Sub-menu, as the right picture.

【BRIGHT】 : To Setting Valued ranged: 0-14, default setting is 8.

【CONTRAST】 : To Setting Valued ranged: 0-14, default setting is 7.

【SHARPNESS】 : To Setting Valued ranged: 0-15, default setting is 5.

【ICR】 : To Setting: COLOR / BLACK, default setting Color.

【STYLE】 : To Setting: STANDARD/BRIGHT/RTSP/SOFT, Default setting is Standard .

【GAMMA】 : To Setting Valued ranged: 0-9, default setting 7.

PICTURE	
BRIGHT:	8
CONTRAST:	7
SHARPNESS:	5
ICR:	COLOR
STYLE:	STANDARD
GAMMA:	7
BACK	
EXIT	

◆ P/T/Z

Press the **【MENU】** button to display the OSD menu, Press Up/Down to **【P/T/Z】**, Press Right Button to enter Sub-menu, as the right picture.

【FILP】 : ON/OFF.

【L/R DIRECTION】 : Mirror function, can be setting to ON/OFF, default is OFF.

【AF MODE】 : Auto Focus Mode can be setting to AUTO/MANUAL/ZOOM, default setting Auto.

【AF SENS】 : Auto focus Sensitivity can be setting to NORMAL/LOW, Default Setting Normal

【PRESET FREEZE】 : ON/OFF.

【D ZOOM】 : DIGITAL Zoom can be setting ON/OFF, default to OFF.

P / T / Z	
FLIP:	OFF
L/R DIRECTION:	OFF
AF MODE:	AUTO
AF SENS:	NORMAL
PRESET FREEZE:	OFF
P/T MODE:	NORMAL
PRESET SPEED:	24
BACK	
EXIT	

◆ NOISE REDUCE

Press the **【MENU】** button to display the OSD menu, Press Up/Down to **【NOISE REDUCE】**, Press Right Button to enter Sub-menu, as the right picture.

【2D NR】 : To Setting Valued range: 0-5 / OFF, default setting 2 .

【3D NR】 : To Setting Valued range: 0-5 / OFF, default setting 3 .

【DYN HOT PIXEL】 : To Setting: ON/OFF, default setting is OFF.

NOISE REDUCE	
2D NR:	2
3D NR:	3
DYN HOT PIXEL:	OFF
BACK	
EXIT	

◆ Video Output

Press the **【MENU】** button to display the OSD menu, Press Up/Down to **【VIDEOOUT】**, Press Right Button to enter Sub-menu, as the right picture.

【VIDEO OUTPUT FORMAT】 : Optional: 720P50、720P60/59、1080I50、1080I60/59、1080P25、1080P30/29、1080P50、1080P60/59、2160P25、2160P30/29、2160P50、2160P60/59;

【REBOOT】 : Used to restart the camera after modify the video output or others Communication setting(ID, Protocol, Baudrate, etc).

【UVC】 : Optional: OFF、 UVC、 UVC & UAC.

【DIGITAL AUDIO】 : Optional: OFF、 ON. Using to turn ON/OFF Audio output through HDMI and SDI Interface.

VIDEO OUT	
VIDEO OUT:	1080P60
REBOOT:	
UVC:	UVC&UAC
DIGITAL AUDIO:	OFF
BACK	
EXIT	

◆ SYSTEM SETUP

Press the **【MENU】** button to display the OSD menu, Press Up/Down to **【SYSTEM SETTING】**, press right button to the sub menu, as the right picture shown.

【SYSTEM INFO】 : press right button to the sub menu, as the right picture shown, then you can get camera F.W & IP Address and others Communication Parameters.

【LANGUAGE】 : The language also can be customized to others .

【ZOOM LABEL】 : To setting: ON/OFF.

【PROTOCOL】 : To setting: VISCA、PELCO-D、PELCO-P.

【CAM ADDRESS】 : To Setting Valued range: 1-255 & Auto, default setting is Auto.

【BAUDRATE】 : To setting:2400、4800、9600、19200、38400.

【OSD SIZE】 : Used to set the font size of the OSD, which can be set to 1X, 2X, and it will be valid after restarting the camera.

【TALLY MODE】 : Used to set the brightness level of the tally light, To setting: off, low, medium and high.

SYSTEM SETUP

SYSTEM INFO

LANGUAGE:	CHINES
ZOOM LABEL:	ON
PROTOCOL:	VISCA
ADDRESS:	AUTO
BAUDRATE:	9600
OSD SIZE:	X2
TALLY MODE:	HIGH
BACK	

SYSTEM INFO

FIRMWARE	V1.02
PROTOCOL:	VISCA
BAUDRATE:	9600
CAM ADDRESS:	AUTO
IP :	192.168.5.162
VIDEO OUT:	1080P60
BACK	

◆ DEFAULT SETUP

Press the **【MENU】** button to display the OSD menu, Press Up/Down to **【DEFAULT SETUP】**, press right button to restore camera changed to the factory default.

DEFAULT SETUP

FACTORY DEFAULT	
BACK	

IV、 Network Environment

4.1 Operating Environment

Operation System: Windows 7、 Windows 10、 Windows 11、 MacOS 10.12、 ChromeOS 16.

Network Protocol :TCP/IP

Client PC: 128MRAM, graphics card that supports scaling, Direct X 8.0 or above

4.2 Connection Mode

【Direct Connection Mode】 : Connect camera with computer through network cable directly.

【LAN Connecting Mode】 : Connect the camera to the Internet, which can be connected to the network through a router or a switch, and users can log in to the device through a browser

【Note】

- Do not place wires and network cables in places that are easy to be touched by humans, so as to avoid line contact Defects cause unstable signal transmission and affect video quality.

- The computer must be works with the same network segment where the camera IP is located. If the network segment is not added or modified, it will fail to log in For example, the default IP address of the camera is 192.168.5.162, and a network segment needs to be added to the computer The specific process is as follows.

- First, open [Properties] at computer's local network, then select "Internet Protocol Version 4(TCP/IPv4)" and double click or click its [Properties] and enter. And then click [Advanced] to enter into Advanced TCP/IP Settings. Input IP and subnet mask and click [Add] to finish. Users could change the camera IP address with relevant net segment.**(Don't clash the IP with other computers or IP device when adding IP address. Please make sure whether the IP you need is available or not before adding)**

- To verify whether the addition of the network segment is successful, open "Start" in the computer, select "Run", enter cmd, click "OK", open the computer DOS command window, enter ping 192.168.5.162, and press the Enter key to display the information as shown in the figure: Description Added successfully.

```

C:\WINDOWS\system32\cmd.exe
Microsoft Windows [版本 10.0.14393]
(c) 2016 Microsoft Corporation. 保留所有权利。

C:\Users\Engineer_T>ping 192.168.1.162

正在 Ping 192.168.1.162 具有 32 字节的数据:
来自 192.168.1.162 的回复: 字节=32 时间=1ms TTL=64
来自 192.168.1.162 的回复: 字节=32 时间=1ms TTL=64
来自 192.168.1.162 的回复: 字节=32 时间=1ms TTL=64
来自 192.168.1.162 的回复: 字节=32 时间=1ms TTL=64

192.168.1.162 的 Ping 统计信息:
    数据包: 已发送 = 4, 已接收 = 4, 丢失 = 0 (0% 丢失),
    往返行程的估计时间(以毫秒为单位):
        最小 = 1ms, 最大 = 1ms, 平均 = 1ms
C:\Users\Engineer_T>

```

Note: After the product power-on self-test is completed, you can also follow the above steps to verify whether the network connection is normal.

4.3 CGI /GUI Operation

◆ Environment Support

Mainstream Chrome, Firefox, 360 Safe Browser, Edge, Safari, (the above dual-core browsers do not support IE mode).

◆ Login

Enter the IP address of the device in the address bar of the browser (the default is 192.168.5.162), press Enter to enter the web client login interface/Web GUI, and enter the user name and password (admin/admin) to log in.

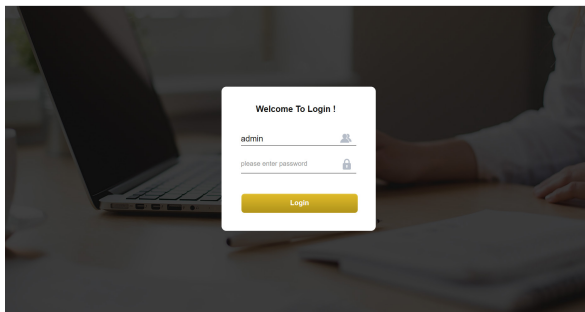

◆ Preview

After the login is successful, The default is to enter the preview interface. In the preview interface, you can perform operations such as PTZ control, zoom, focus, language switching, and full-screen images as shown in the following pictures.

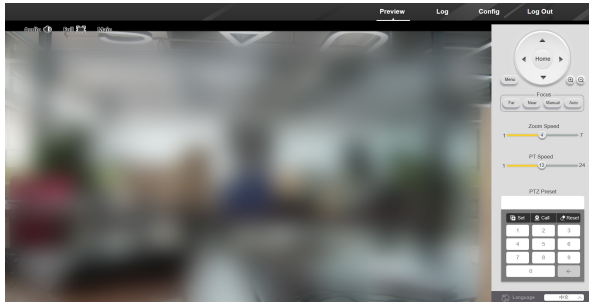

【Audio】 : The default is off. Click the audio icon to choose to turn on/off . When the audio output is turned on, the audio icon is highlighted.

【Full Screen】 : Click this icon to enter full screen mode.

【HOME】 : The image returns to the predetermined origin, that is, the HOME position.

【Menu】 : Click to enter the camera OSD menu, use the up and down arrows to select the PTZ menu item, and the left and right arrows to modify the parameter value.

【Focus】 : Click the manual button, and the camera will switch to manual focus mode. At this time, you can manually adjust the focus position of the lens by clicking the far and near buttons. Click the automatic button, and the camera will switch to automatic focus mode.

【Zoom button】 : Click the + button to control the lens for TELE zoom, click the - button to control the lens for WIDE zoom.

【Zoom Speed】 : User can move the progress bar to adjust the speed(default 4, optional 1~7).

【PTZ Preset】

Setting: Enter the number of the preset position to be set, and click Set to save the current Position,ZOOM and other parameters to corresponding preset position.

Call: Enter the preset number that needs to be called, and click to call Presets.

Clear: Enter the preset number to be cleared, and click Clear Presets

Language: Used to modify the language and text display of the web page. Chinese and English are optional.

◆ Log

Click "Log" to enter the Log interface, choose the appropriate time and type to find log information as shown in the following pictures.

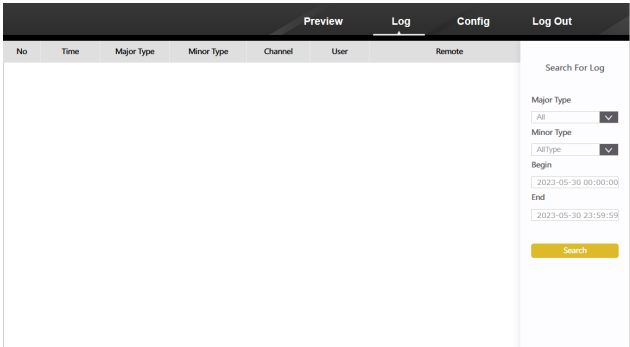

◆ Config

Click "Config" to enter the Config interface. By default, the three basic information and configurations of "Version", "Time" and "Maintenance" are displayed.

- The "Version" is used to show the unmodified information.
- The "Time" is used to use NTP in different regions or manually update the internal time of the device.
- The "Maintenance" is used to reboot, Restore and upgrade the device.

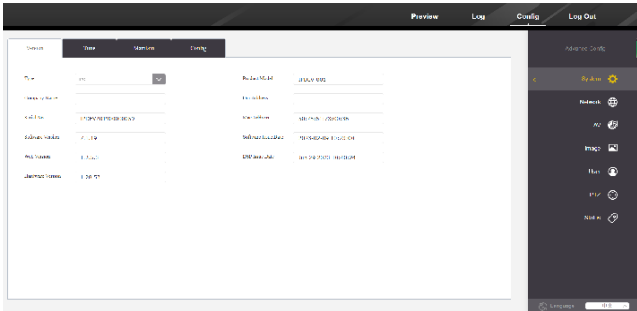

【 System】

Click the "System" to enter the system interface, the "Config" was added.

◆ Version

For display only, not modifiable. The displayed content includes device type, Device model, Manufacturer name, Manufacturer address, network Mac address, Software version, Software compilation date, Web GUI software version, DSP software compilation date, Hardware version, etc

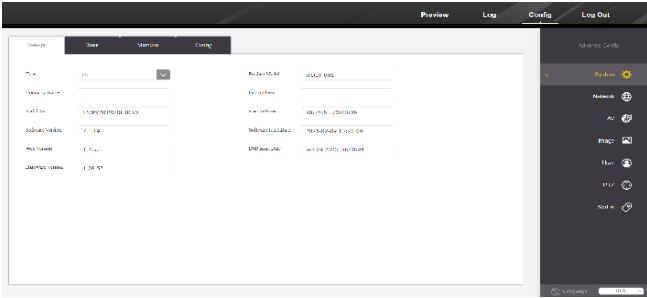

◆ Time

Used to use NTP in different regions or manually update the internal time of the device.

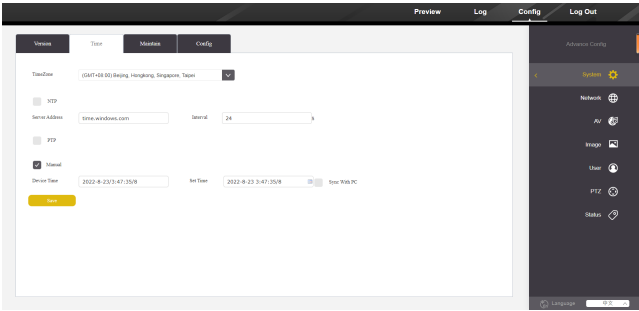

【TimeZone】 : to choose a different time zone.

【NTP】 : Calibrate the device time through an external server.

【Manual】 : Manually modify or synchronize the local computer time to calibrate the device time.

◆ Maintenance

Used to reboot, Restore and upgrade the device.

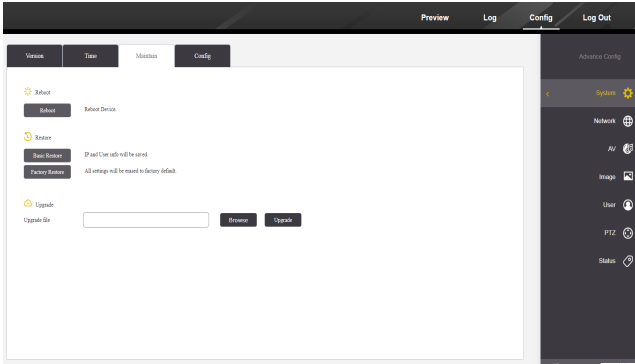

【Reboot】 : After clicking the button, the device will restart.

【Basic Restore】 : After clicking the button , most of the data will be restored to factory default and the camera will automatically restart.

【Factory Restore】 : All settings will be erased to factory default and the camera will automatically restart.(note that the IP address will also be restored, the default IP address is 192.168.5.162).

【Upgrade】 : When the camera need the upgrade, to choose the upgrade firmware (bin file format) provided by the manufacture and click upgrade.The camera will automatically start updating and show a progress bar. and the camera will automatically restart when the update is complete.

◆ Config

【Video Standard】 : to choose different signal output format(Default BT.1120)

【Video Output Mode】 : to select the resolution and frame rate (the default options are different according to different devices, generally you can choose 720P50、720P60/59、1080P25、1080P30/29、1080P50、1080P60/59、1080I50、1080I60/59、2160P25、2160P30/29、2160P50、2160P60/59)

【UVC】 : Select whether to output UVC signal or UVC+UAC signal through the USB port of the camera, the default is off.

【Name】 : You can customize the name of the device.

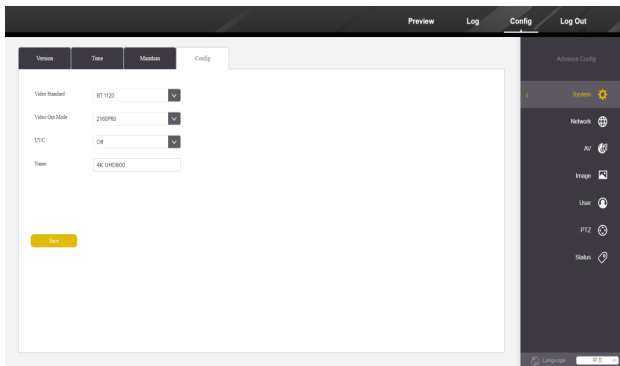

◆ Network

Click the “Network” on the right to enter the Network interface.

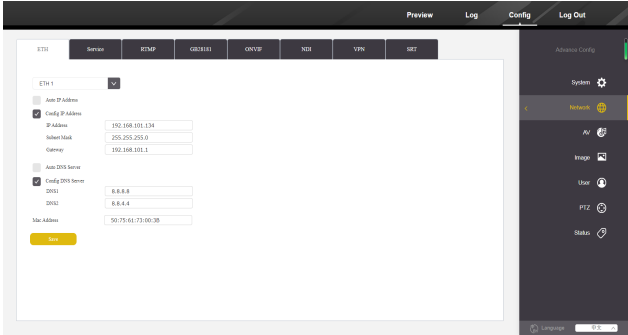

[EHP] : Set the IP address and its DNS Server of the device. Note that the IP address is consistent with the gateway, and the Mac address cannot be modified.

ETH	Service	RTMP	GB28181	ONVIF	NDI
VPN	SRT				

ETH 1 ▼

Auto IP Address

Config IP Address

IP Address

Subnet Mask

Gateway

Auto DNS Server

Config DNS Server

DNS1

DNS2

Mac Address

Save

◆ Service

ETH	Service	RTMP	GB28181	ONVIF	NDI
VPN	SRT				
Msg Port	<input type="text" value="8080"/>				
Rtsp Port	<input type="text" value="554"/>				
Http Port	<input type="text" value="80"/>				
VISCA Port	<input type="text" value="52381"/>				
WebSocket Port	<input type="text" value="8880"/>				
<input type="button" value="Save"/>					

【Msg Port】 : Message Port for private protocol (default 8080).

【RTSP port】 : The port was used when previewing video with the Rtsp protocol (default 554, 0~65535 optional).

【Http Port】 : The port was used to set the browser. Since the default port of commonly used browsers is 80, you can directly enter the IP address of the camera in the browser address bar to open the web page. If the user manually changes the port from 80 to others, you need to enter Add the modified http port Browser address bar and then to open the web page, for example: 192.168.5.162:81. When this port is repeated with other port , the camera will automatically change the port to 81 (default 80, 0~65535 optional).

【VISCA Port】 : The port was used when controlling the camera through the VISC Over IP protocol (default 52381, 0~65535 optional). Also named UDP Port.

【WebSocket port】 : The port number used when previewing video using the WebSocket protocol,Such as web video. (default 8880, 0~65535 optional)

◆ RTMP Streaming

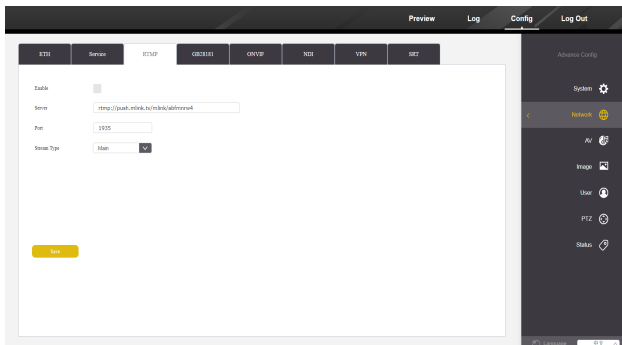

【Server】 : RTMP server address, generally used for webcasting, obtain the RTMP streaming server address (usually rtmp://IP address: port /platform live segment/platform live code) on its live broadcast platform, and copy it Go to "Server Address", turn on the streaming switch, and click Save to preview the screen on the platform.

【Port】 : The port was used to streaming.

【Stream Type】 : The stream type used when streaming (default main stream, optional main stream,second stream).

◆ ONVIF Config

【ONVIF Authentication】 : It is used to select whether a password is required for ONVIF connection.

【ONVIF Server Port】 : ONVIF Port Number, can be setting according to User. Default PORT 8000.

【ONVIF RTSP Authentication】 : It is used to select whether a password is required for ONVIF preview.

【ONVIF RTSP port】 : The port used when use ONVIF RTSP to streaming.

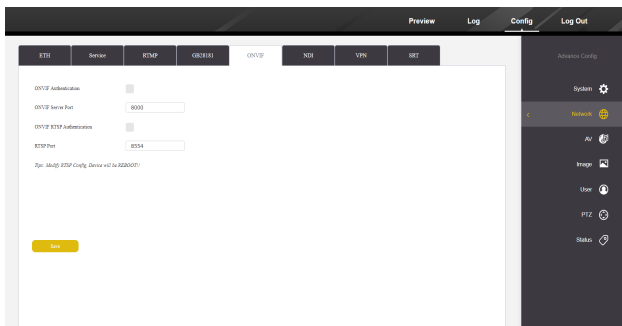

◆ NDI

Streaming setting (This function is limited to cameras that support NDI)Network Device Interface (NDI) is a software specification developed by NewTek that enables high-definition video to be delivered, received, and communicated over a computer network in a low-latency, high-quality manner.

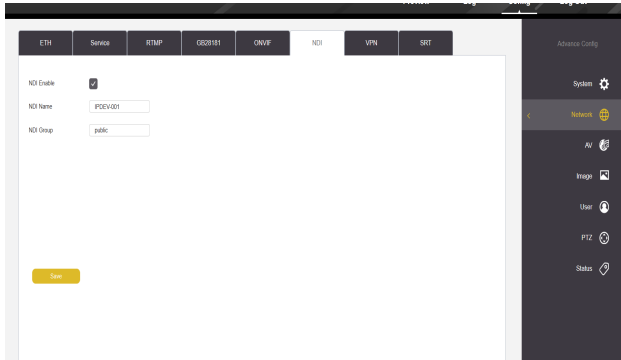

【NDI Enable】 : if you wanted to starting using NDI function, then you need to click this button to enable NDI function.

【NDI Name】 : The User can changed & setting the NDI Camera name according to need. Default is IPDEV-01

To download NDI Tool, click the link: <https://www.newtek.com/ndi/applications/> And then operation it

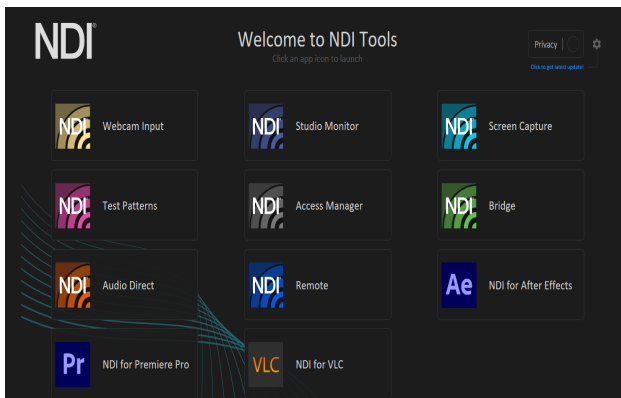

If you want to modify the video parameters, you can operate on the web interface in AV Setting

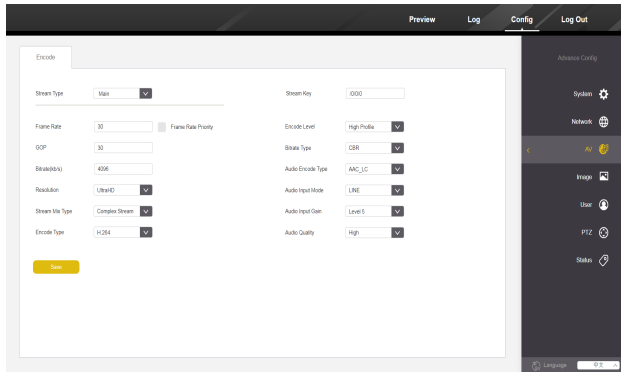

◆ VPN

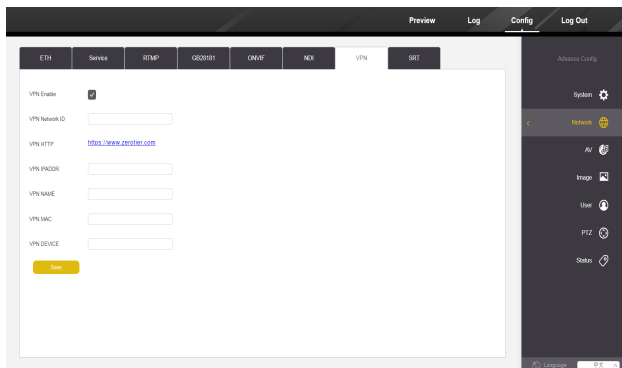

【VPN Enable】 : Used to enable or disable VPN service

【VPN Network ID】 : Set the VPN Network ID

【VPN HTTP】 : Show the VPN official address

【VPN IPADDR】 : Show the VPN device IP address

【VPN NAME】 : Show the VPN device name

【VPN MAC】 : Show the VPN device MAC address

【VPN DEVICE】 : Show the VPN device name

◆ SRT

SRT stands for 'Secure Reliable Transport', and is an open source video transport protocol and technology stack. SRT uses secure streams and easy firewall traversal to optimize streaming performance and deliver high-quality video over even the most unreliable networks.

The SRT protocol uses end-to-end 128/256 bit AES encryption to ensure that content is protected from contribution to distribution. It also provides the ability to configure specific controls that allow users to correct for specific network challenges in order to deliver low latency video and protect against jitter, packet loss, and bandwidth fluctuation.

The SRT Open Source Project is largely driven by the SRT Alliance, which was founded by Haivision.

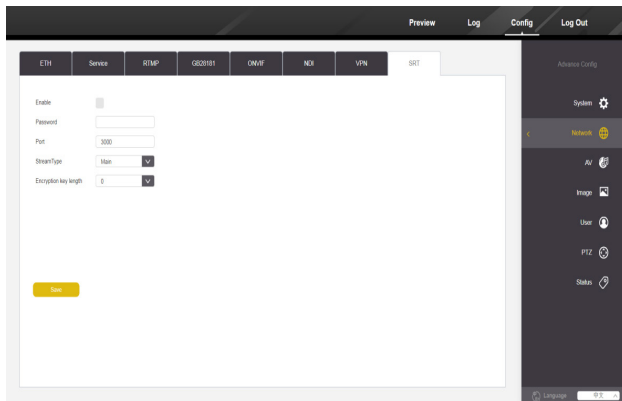

【Enable】 : Click this button to Turn ON /OFF SRT Streaming.

【Password】 : The User can setting to any number of character as the password

【Port】 : ·default setting 3000, (1024-65535 optional)

【Streaming Type】 : The User can setting the Streaming in Main Streaming or Second Streaming.

【Encryption Key Length】 : The User can setting to the password number of Character length, Max support 36 bits

1.Link to SRT, if have no setting passVword on the WEB interface of the device.

Enable

Password

Port

StreamType

Encryption key length

The link of SRT format is srt://ip address:port number. The port number is the port number set on the WEB side of the device.

SRT://192.168.5.162:3000

2.If the password was set, the link need the keyword.

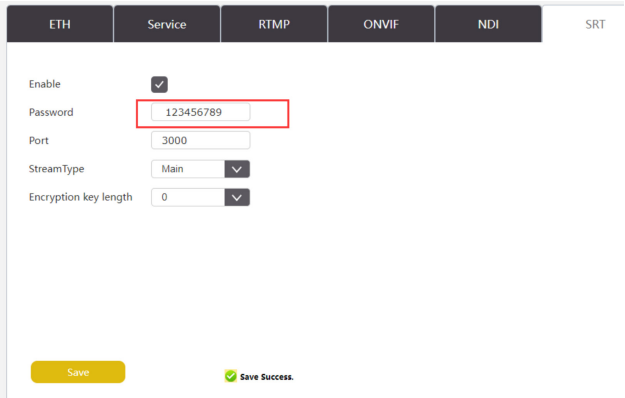

The link of SRT format is srt://ip address:port number?Pasaphrase=password
Example : SRT://192.168.5.162:3000?Pasaphrase=123456789

3.If you want to modify the video parameters, you can operate on the web interface.

◆ AV

Click the “AV” on the right to enter the AV interface.

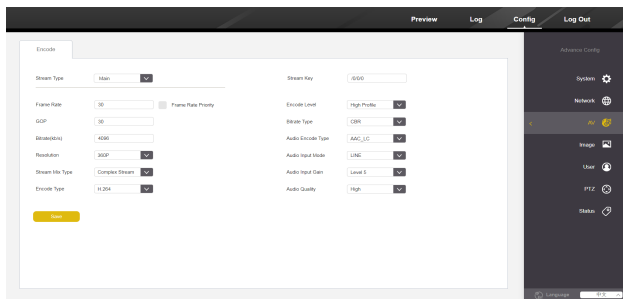

【Stream Type】 : You can choose the main and second streams. and The user configures the parameters of the corresponding stream according to the needs (the web page generally uses the main stream and cannot be changed)

【Frame Rate】 : Set the number of frames per second for video transmission. it can be set up to 60fps depending on the device, beyond 60fps which it will not take effect.

【GOP】 : Set its key frame (I frame) according to the standard encoding, that is, how many frames are included in an I frame.Different from B and P frames, I frame contains all the information of the screen, so its volume is also the largest.All the B and P frames that appear before the next I frame are based on the I frame, therefore, the interval between I frames should not be set too large, so that when the I frame is damaged, all the B and P frames (GOP) behind it cannot be parsed normally. The I frame interval should not be set too small to avoid network transmission pressure, the default is 30.

【Bitrate (kb/s)】 : You can set the bitrate of the video. The higher the bitrate, the higher the quality and the richer the picture details, but the larger the transmission bandwidth occupied. The default is 4096.

【Resolution】 : You can set the resolution of the video, the higher the resolution, the richer the picture details (the default is 1080P or 2160P, 1080P and 720P are optional)

【Stream Mix Type】 : Composite stream means audio and video mixed, video stream means only video without audio, the default is composite stream.

【Encode type】 : You can set the video encoding method, supporting mainstream standards such as MJPEG, etc.

【Encode Level】 : Set the audio and video encoding level . Base Line is generally used for low-level or applications that require additional fault tolerance. Main Profile is generally used for mainstream consumer electronics product specifications. High Profile is generally used for broadcasting and video discs. Storage (Blu-ray movies), etc, HDTV applications.

【Bitrate Type】 : Set the Bitrate type (default CBR, optional CBR, VBR and FIX QP).

【Audio Encode Type】 : Set the type of input audio. Default LINE input (with gain), optional MIC input (without gain)

【Audio Input Mode】 : Set the type of input audio. Default LINE input (with gain), optional MIC input (without gain).

【Audio Input Gain】 : Set the gain of the audio input (default Level8, optional mute, Level1~Level10).

【Audio Quality】 : Set the audio sampling frequency, optional low (8Khz), high (48Khz for AAC encoding, 24Khz for G711 encoding).`

◆ Image

Click the “Image” on the right to enter the image interface.

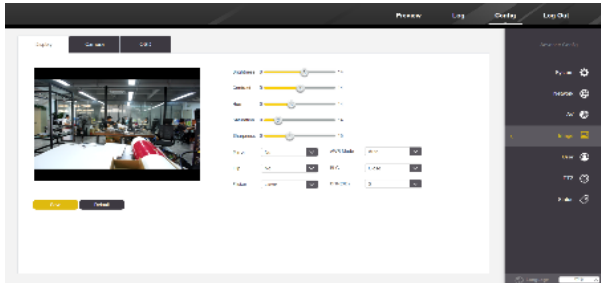

【Display】 : You can set the parameters that directly affect the image effect.

Brightness: set brightness (default 8, 0~14 optional)

Contrast: Set the contrast (default 7, 0~14 optional)

Hue: set the Hue (default 5, 0~14 optional)

Saturation: set saturation (default 2, 0~14 optional)

Sharpness: set sharpness (default 5, 0~15 optional)

Mirror: set whether the image is mirrored (the default is not mirrored)

Flip: Set whether the image is flipped (default is not flipped)

Flicker: Modify the shutter speed of the camera so that the camera can synchronize the flicker frequency of the external environment (default off, 50HZ, 60HZ optional)

AWB Mode: set the white balance mode (Auto, Trigger, ATW, indoor, 3000K, 4000K, 5000K, 6500K, outdoor, manual optional)

DNR (3D): You can set the noise reduction level (default 2, off, 1~5 optional)

【Camera】 : Advanced Image Settings.

Focus Mode:Set the Focus Mode of the lens (default Auto, optional Auto, Z-trigger, Manual)

Near Limit: Set the Near Limit distance of the lens (default 30cm, optional 10cm,30cm, 1m, 2m, 3m、 6m、 10m、 50m,infinity)

Sensitivity:Set focus sensitivity (default Normal, optional Normal, Low)

ICR Mode:Set the shooting environment of the device to match better image effects (default Day, optional Night,Day)

AE Mode: Set the AE Mode of the device (default auto, optional auto, shutter priority, Iris priority, manual, bright)

HLC: Set whether the HLC of the device is enabled and its level (default level 8, optional off, level 1~level 15)

DNR (2D): Set the 2D noise reduction level of the device (default level 3, optional off, level 1~level 5)

Gamma: Set the Gamma of the device, that is, the Gamma level (default Gamma6, optional Gamma 0~Gamma9)

AE Level: Set the AE Level when the device is shooting to achieve the desired screen brightness effect (default 7, optional 0~14)

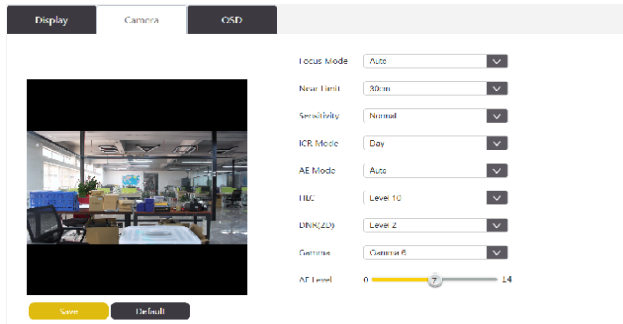

[OSD] : Set the display content on the network video image, and adjust the display position by dragging.

Color: Call up the artboard by clicking the color box, and choose the color of the OSD characters.

Font Size: Set the font size of the OSD (default Middle, optional small, Middle, Big)

Date: Whether to display the internal time of the device, you can modify the displayed position by dragging the time characters on the screen with the mouse.

Text: The content displayed on the screen can be customized, and the displayed position can be modified by dragging the characters on the screen with the mouse.

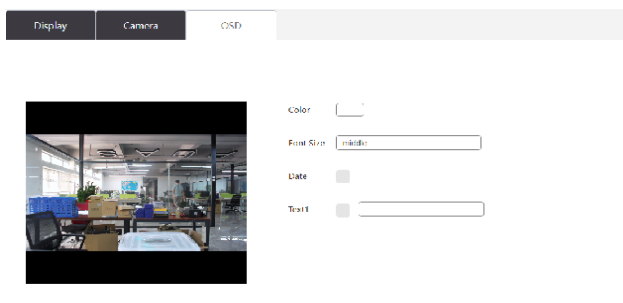

◆ User

Click the “ User ”on the right to enter the user interface.

1:Click the User Name-admin, and then click the Modify .



User Manager

Modify

No	User Name	Local Right	Remote Right
1	admin	-1	-1

2:Enter the new information of the User Name and password and click save.

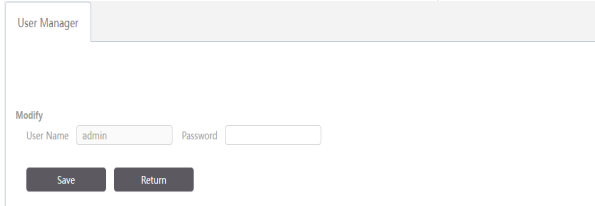

User Manager

Modify

User Name Password

Save Return

◆ PTZ

Click the “ PTZ ”on the right to enter the PTZ interface.

【Serial】 : The serial port of the PTZ (default 1, depending on the PC hardware configuration and the operating system’s support for the serial port).

【PTZ Addr】 : Used to set the address code of the camera.

【Protocol】 : Set the PTZ protocol (default Visca, optional Visca, Pelco-d, Pelco-p).

【BaudRate(bps)】 : The BaudRate of the PTZ (default 9600, optional 2400, 4800, 9600, 19200, 38400).

【LR- Direction】 : whether the direction of the PTZ is reverse.

【Mount Mode】 : Whether the PTZ is flipped.

【Display Mag】 : Whether to display the Zoom Label in Screen.

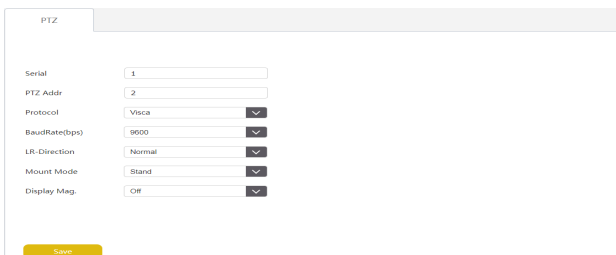

PTZ

Serial

PTZ Addr

Protocol ▼

BaudRate(bps) ▼

LR-Direction ▼

Mount Mode ▼

Display Mag. ▼

Save

◆ Status

Click the “Status” to enter the Status page. This page is used to view the status of each video stream. Click Refresh to update and display the latest stream status.

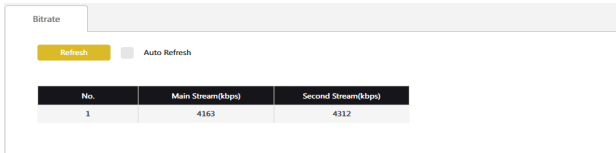

The screenshot shows the 'Bitrate' section of the interface. It includes a yellow 'Refresh' button and an 'Auto Refresh' checkbox. Below is a table with the following data:

No.	Main Stream(kbps)	Second Stream(kbps)
1	4363	4312

◆ Log Out

Clicking on the “Log Out” which will prompt you to log out. Selecting Sure ,it will log you out and take you to the Homepage.

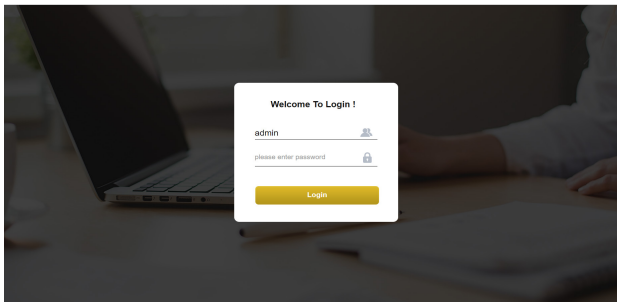
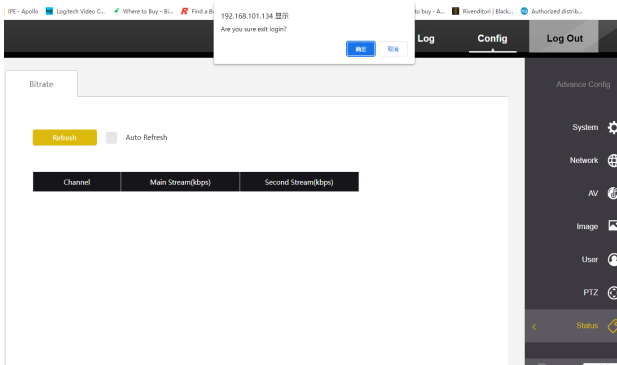

V、 Installation Instruction

Notes

- Be sure to provide safety measures against falling when you mount the camera.
- Do not grasp the camera head when carrying the camera.
- Don't turn camera head manually. Doing so may result in mechanical damage.

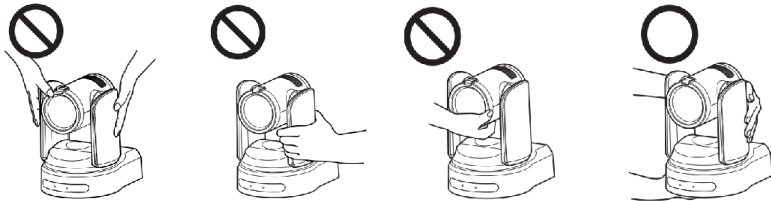

5.1 Installing the camera on a desk

Place the camera on a flat surface. If you have to place the camera on an inclined surface, make sure that the inclination is less than ± 15 degrees to guarantee pan/tilt performance, and take measures to prevent it from falling.

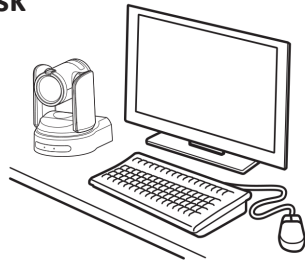

5.2 Mount the camera on a tripod

Screw the tripod screw into a tripod screw hole on the bottom of the camera. The tripod should be placed on a level surface, and tighten the screw firmly by hand. The tripod screw should be compliant with the following standards.

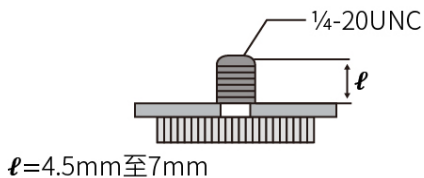

5.3 Installing the camera at a high spot (ceiling)

The camera can be mounted on a ceiling or on a shelf or stand located at a high spot using the supplied ceiling bracket. The surface on which the camera will be mounted should be level. If you have to mount the camera on a tilted surface, make sure that the angle is less than 15 degrees to ensure the camera can pan/tilt properly.

◆ Mounting the camera on the ceiling (example)

1. Attach the ceiling bracket (B) to the attachment materials (not supplied) to mount the camera on the ceiling. Be sure to attach it so that the triangle sign hole of the ceiling bracket (B) is placed where the front of the camera will face.

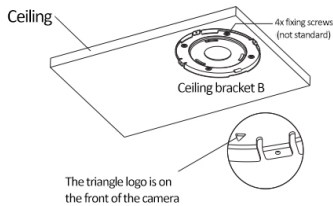

2. Mount the ceiling bracket A to the bottom of the camera using the 4 screws provided (M4 X 8) as shown cam.

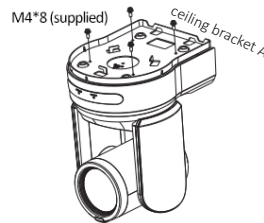

3. Fasten the safety wires to the ceiling brackets A and B respectively. Make sure that the triangle marks of ceiling bracket A and bracket B are aligned as shown in the figure, and then rotate the camera clockwise so that ceiling bracket A and bracket B are fully locked.

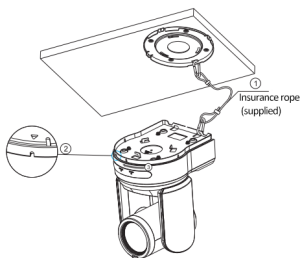

4. Fix ceiling brackets A and B using the three screws provided (M3 X 8).

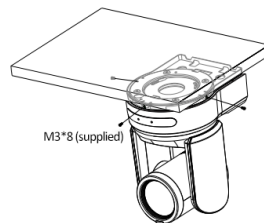

◆ Installing the camera at a high spot (Wall mount-Standard)

Secure the wall mount bracket to the wall with four screws (not provided) for installation. Select the correct type of screws according to the shelf material. Align the bottom bracket hole of the camera with the holes of the wall bracket, and use the provided 4 screws (M4X8) to fix the camera on the wall bracket.

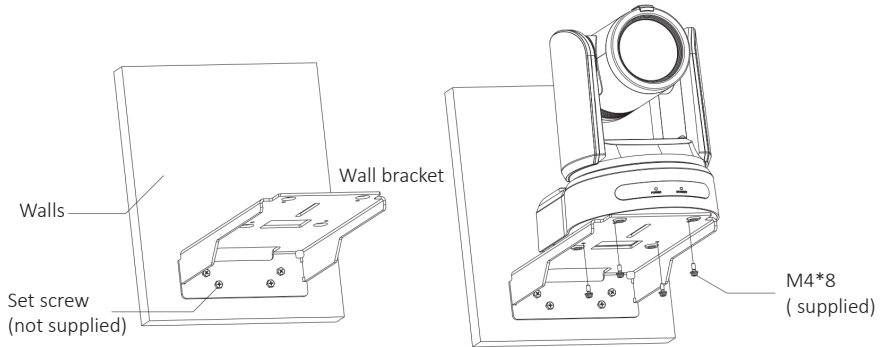

◆ Installing the camera at a high spot (Wall mount Top-down)

Secure the wall mount bracket to the wall with four screws (not provided) for installation. Select the correct type of screws according to the shelf material. Align the bottom bracket hole of the camera with the holes of the wall bracket, and use the provided 4 screws (M4X8) to fix the camera on the wall bracket.

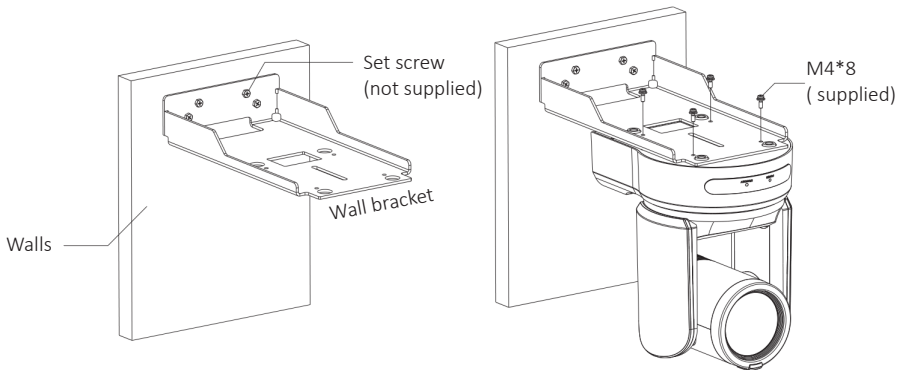

VI、 Maintenance Service Terms

6.1 Warranty Terms

- The product will be maintained free for one (1) years.
- The product will be obtained the free maintenance service if the same malfunction appears again within three payable maintenance months.
- Duo to force majeure reason(Such as War, Earthquakes,Lightning, etc) or improper use, Installation errors and other non-normal operation or accident by failure is not covered by free warranty.
- In the process of transportation and storage, it is necessary to prevent damage to the product caused by heavy pressure, violent vibration, and rainwater immersion, and the damage caused by this is not within the scope of free warranty.
- This product must be transported in overall packaging and original packaging materials. If the product is damaged due to the use of separate packaging or is not transported in the original packaging, it is not within the scope of free warranty;
- Users are prohibited from disassembling the machine without permission. Products that are disassembled and repaired by users themselves are not covered by free warranty. For faulty products that exceed the warranty period, the company will be provide lifetime paid maintenance services
- For products repaired within the warranty period, please fill in the product warranty information form correctly, describe the failure phenomenon in detail, and provide the original or copy of the invoice or purchased records
- The manufacturer does not assume any risk and responsibility for damage or loss caused by the specific application of the product. The manufacturer's compensation for the product related to breach of contract, negligence or infringement shall not exceed the amount of the product sold. The manufacturer's compensation for any special damage caused by any other reason shall not be liable for any sudden or consequential damages.
- The company will reserve the final interpretation of the above terms.

6.2 Warranty Conditions

For products that need to be repaired, the User or Reseller needs to provide the product warranty card and detailed fault phenomena with the product to us.

6.3 Shipping in RMA

When the product needs to be returned to the manufacturer for maintenance, the customer can return it to the us direct or return it to the manufacturer through the distributor or Reseller. When returning the goods directly to the us, please contact us to expedite the processing of the goods. The company only bears the one-way freight sent by the manufacturer to the customer after maintenance.



With this card for warranty, please keep it for product warranty, cut this page when you need for RMA Service.

Products Warranty Cards

User Information

Date: _Day_ Month _Year

Name		Purchased Date	
Add			
Tel/Fax		Post Code	
Purchased Place			
Model/Specs		S/N	
Malfunction Phenomenon			
Distributor(Chop)		User Signature	

User files are warranty and basic documents, please fill in and keep them carefully & Saved it.



Thanks for your purchase of our company's video PTZ camera products, we would like to thank you again!

In order to protect your legitimate rights and interests, avoid your worries, and improve the after-sales service for customers, this warranty regulation is specially formulated. Please read it carefully and provide valuable opinions and suggestions.
